



*ahşap  
antik  
rustik*

*Kiraz*

# *biz kimiz?*

1985'ten bu yana güçlü çekirdek kadromuzla, tecrübeli çalışanlarımızla Türkiye'de ahşap sektöründe yer almaktayız. İkinci kuşak geleneğinin mirasçıları olarak babadan devraldığımızda mesleğimizi başarılı bir şekilde devam ettirerek sektörün parlayan yıldızlarından biri haline gelmeyi başardık.

Geçmişten gelen tecrübemizle geleceğe artı değer katmak için yenilikçi atılımlar gerçekleştiriyor, bilim ve teknolojiden aldığımız güç ile ahşabı en modern haline büründürüyoruz. Gelişmekten korkmuyor, yerimizde durmaktan kaçınıyoruz. "Hiçbir kalite tesadüfi değildir" mottosuyla gerçekleştirdiğimiz her yatırımla gün geçtikçe büyüyerek, gücümüze güç katmaya devam ediyoruz. Peki biz neler yapıyoruz? Ekibimizin profesyonelleri aklınızdaki tasarımları etkili bir şekilde ahşaba işleyebilmek için yeni nesil teknolojilerle sizleri buluşturuyor. En kaliteli malzemeler fabrikamızda özenle işleniyor ve olanca titizliğiyle ahşaba son hali veriliyor. Müşteri memnuniyetini esas alan hizmet anlayışıyla ve geniş lojistik imkanlarla ürününüz sizlere ulaştırılıyor.

## *misyonumuz*

Geçmişten başlayan ahşap dekorasyonu yolculuğumuzda ustalığımızı edinirken zorlu yollardan geçtik. Zor şartlar altında pes etmedik, Her zaman emin adımlarla ilerledik. Ustalığımızı geliştirirken profesyonel yol arkadaşları edindik. Ve geçmişten birikerek bugünlere gelen tecrübemizi, geleceğe taşıırken yeni nesil teknolojilerin gücünü arkamıza alarak güçlü bir şekilde kendimizi ve ekibimizi geliştirmeye devam ediyoruz. En önemli misyonumuz müşterilerimizin isteklerini yerine getirirken en kaliteli ürünleri, en iyi işçilikle işleyip dürüstlüğümüzden taviz vermeden zamanında ve müşteri memnuniyetini esas alan bir yaklaşımla en uygun maliyet avantajlarıyla teslim etmektir. Var olan kökten tüketici sistemlerin aksine; doğaya vereceğimiz zararı en aza indirmek için, hammadde tüketimini ve enerji tüketimini minimuma indirgeyen akıllı sistemler vasıtasıyla daha sürdürülebilir bir üretim biçimini esas almaktayız. Ürettiğimiz her bir ürün için doğaya bir ağaç kazandırmayı, gelecek nesillere bırakılacak mirasta boynumuzun borcu biliriz.

## *vizyonumuz*

Sürekli büyüyen ahşap pazarı ihtiyacına yanıt vermek için, büyüyen pazar ihtiyaçlarıyla doğru orantılı olarak büyüüp gelişerek, Türkiye'de ahşap sektöründe ve pazarında lider konuma ulaşmaktır. Bunun için, gelişen yapay zekâ teknolojilerinin ve akıllı sistemlerin gücüyle çalışan, son teknoloji makinelerle daha kaliteli ahşap dekorasyonları ülkemize kazandırıp, her zaman en kaliteli hammaddeleri işleyip en verimli ürünleri ortaya çıkartmaya çalışacağız. Ahşabın en minimalistik halini zarif tasarımlarla taçlandırıp, Türk ahşap ustalığının estetik algısını tüm Dünya'da yüceltmekte vizyonumuzun temel taşlarından. Genç insanların istihdam sağlayabileceği iş kolları oluşturmak, daha modern bir usta-çırak ilişkisi modeliyle ilerlemek ve yeni ustaları toplumumuza kazandırmaya devam etmekte, geleceğe dair vizyonumuzun en güçlü öğelerinden birisidir.

*Kiraz*

# ahşap antik rustik

Kiraz Rustik olarak mekânlarınıza şıklık, modernlik ve yenilik getirecek yeni ürünümüzü sunuyoruz. Tasarımlarınızda farkınızı ortaya koymak için, yeni ve özel üretim olan Ahşap Antik Rustik ile siz de perdelerinizi yenilemek isteyeceksiniz!

Mekânlarınızda yeni bir dünya yaratmak istediğinizde perdeler en önemli tamamlayıcı ürünlerdir.

Ahşap Antik Rustik yetenekli ustalarımızın el işçiliği ile özel olarak kayın ağacından üretilmektedir.

Doğal bir görünüme sahip olan 10 farklı başlık modeli ve 3 farklı renk seçenekleri ile ürün gruplarımız arasında yerini almaktadır.





*Kiraz*

# *uygulama seenekleri*

## *tekli*



Tek Tül veya Perde uygulamalarında önerilen tek kademeli Rustik sistemidir.

## *ikili*



ift Tül ve Fon perde uygulamalarında önerilen ift kademeli Rustik sistemidir.



*Kiraz*

# *rustik başlıklar*

*antik rustik*

altın eskitme R-011 M-706



*antik rustik*

altın eskitme R-011 M-708



*antik rustik*

altın eskitme R-011 M-707



*antik rustik*

altın eskitme R-011 M-705



*antik rustik*

altın eskitme R-011 M-709



*antik rustik*

altın eskitme R-011 M-701



*antik rustik*

altın eskitme R-011 M-700



*antik rustik*

altın eskitme R-011 M-702



*antik rustik*

altın eskitme R-011 M-703



*antik rustik*

altın eskitme R-011 M-704



# *rustik başlıklar*

*antik rustik*

beyaz eskitme R-05 | M-706



*antik rustik*

beyaz eskitme R-05 | M-708



*antik rustik*

beyaz eskitme R-05 | M-707



*antik rustik*

beyaz eskitme R-05 | M-705



*antik rustik*

beyaz eskitme R-05 | M-709



*antik rustik*

beyaz eskitme R-05 | M-701



*antik rustik*

beyaz eskitme R-05 | M-700



*antik rustik*

beyaz eskitme R-05 | M-702



*antik rustik*

beyaz eskitme R-05 | M-703



*antik rustik*

beyaz eskitme R-05 | M-704



# *rustik başlıklar*

***antik rustik***

gümüş eskitme R-071 M-706



***antik rustik***

gümüş eskitme R-071 M-708



***antik rustik***

gümüş eskitme R-071 M-707



***antik rustik***

gümüş eskitme R-071 M-705



***antik rustik***

gümüş eskitme R-071 M-709



***antik rustik***

gümüş eskitme R-071 M-701



***antik rustik***

gümüş eskitme R-071 M-700



***antik rustik***

gümüş eskitme R-071 M-702



***antik rustik***

gümüş eskitme R-071 M-703



***antik rustik***

gümüş eskitme R-071 M-704



# teknik

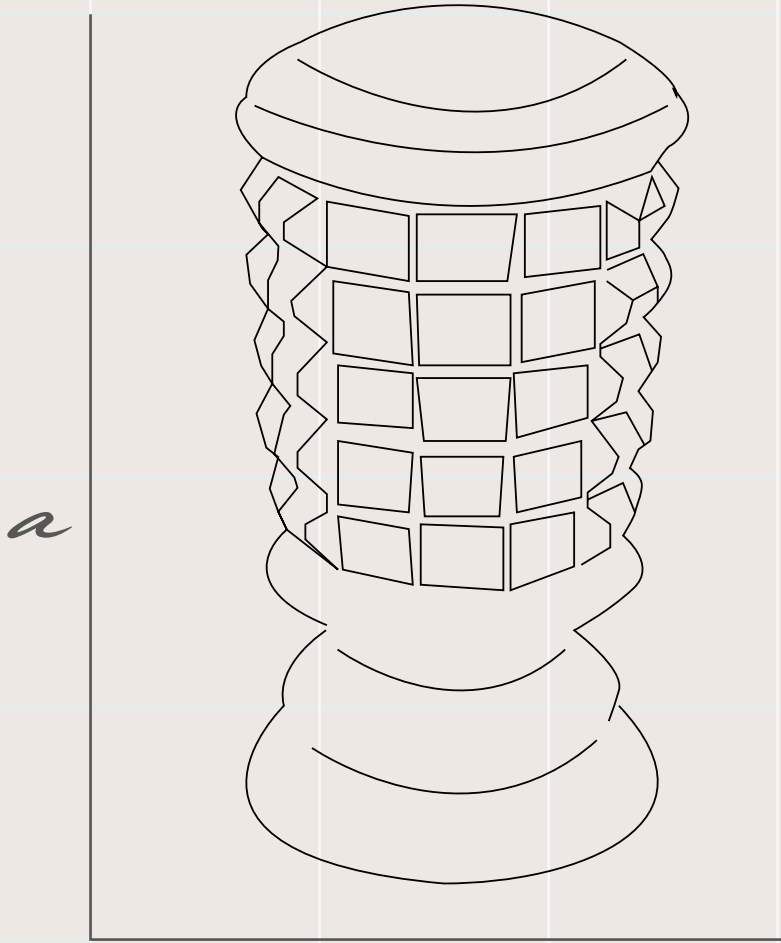

a

b

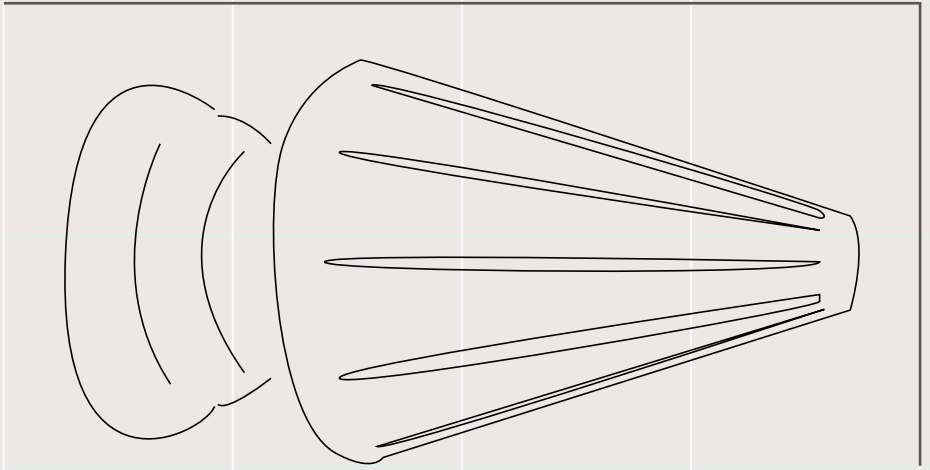

x

y

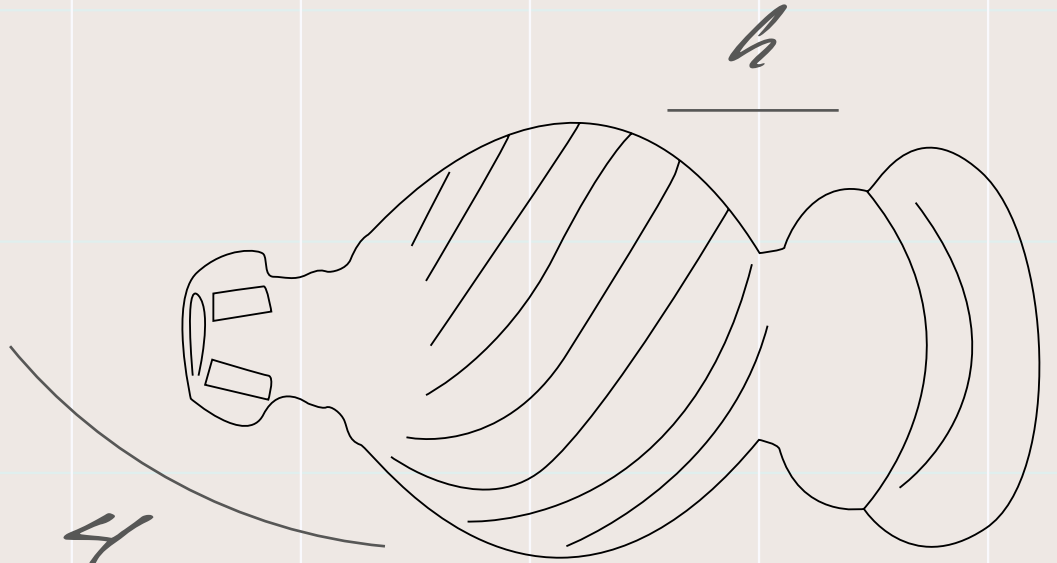

b

4

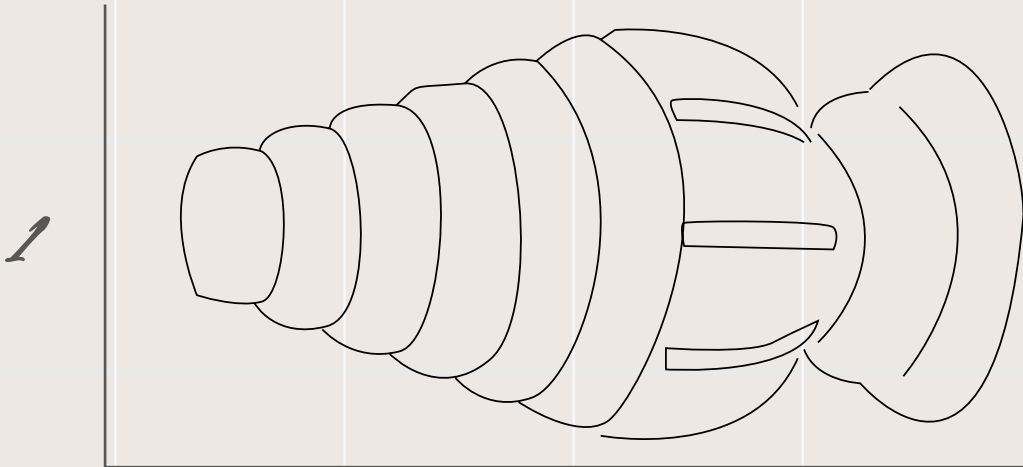

1

3

# *rustik teknik*

Başlık 706

123 mm

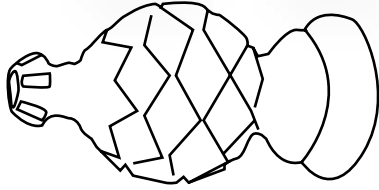

66 mm

Başlık 708

123 mm

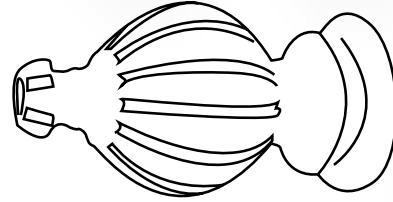

70 mm

Başlık 707

123 mm

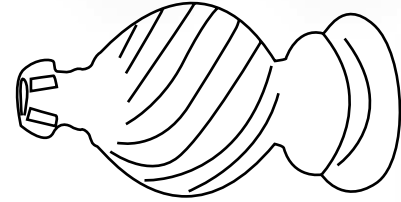

69 mm

Başlık 705

123 mm

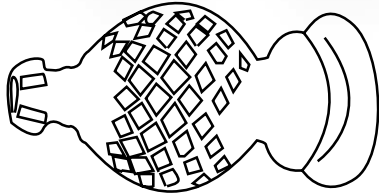

67 mm

Başlık 709

105 mm

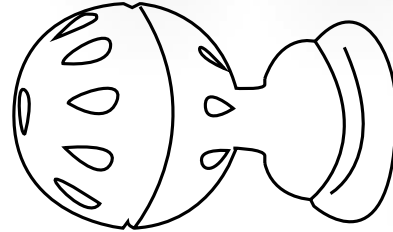

72 mm

Başlık 701

148 mm

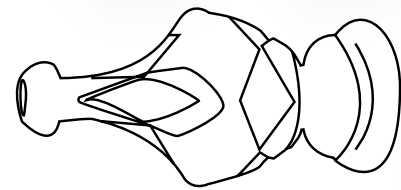

72 mm

Başlık 702

148 mm

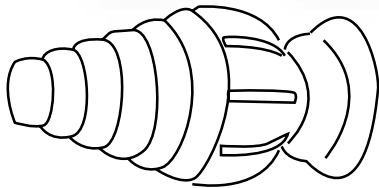

72 mm

Başlık 700

130 mm

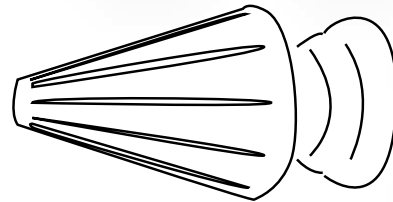

71 mm

Başlık 703

128 mm

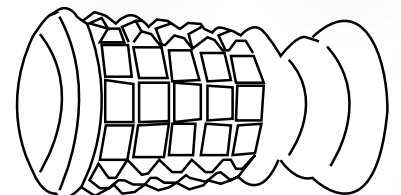

69 mm

Başlık 704

128 mm

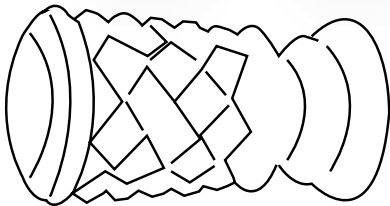

69 mm



*Kiraz*

# *kolbağı başlıklar*

*antik kolbağı*

altın eskitme R-01 | M-706



*antik kolbağı*

altın eskitme R-01 | M-708



*antik kolbağı*

altın eskitme R-01 | M-707



*antik kolbağı*

altın eskitme R-01 | M-705



*antik kolbağı*

altın eskitme R-01 | M-709



*antik kolbağı*

altın eskitme R-01 | M-701



*antik kolbağı*

altın eskitme R-01 | M-702



*antik kolbağı*

altın eskitme R-01 | M-700



*antik kolbağı*

altın eskitme R-01 | M-703



*antik kolbağı*

altın eskitme R-01 | M-704



# *kolbađı bařlıklar*

*antik kolbađı*

beyaz eskitme R-05 | M-706



*antik kolbađı*

beyaz eskitme R-05 | M-708



*antik kolbađı*

beyaz eskitme R-05 | M-707



*antik kolbađı*

beyaz eskitme R-05 | M-705



*antik kolbađı*

beyaz eskitme R-05 | M-709



*antik kolbađı*

beyaz eskitme R-05 | M-701



*antik kolbađı*

beyaz eskitme R-05 | M-702



*antik kolbađı*

beyaz eskitme R-05 | M-700



*antik kolbađı*

beyaz eskitme R-05 | M-703



*antik kolbađı*

beyaz eskitme R-05 | M-704



# *kolbađı bařlıklar*

*antik kolbađı*

gümüř eskitme R-07 | M-706



*antik kolbađı*

gümüř eskitme R-07 | M-708



*antik kolbađı*

gümüř eskitme R-07 | M-707



*antik kolbađı*

gümüř eskitme R-07 | M-705



*antik kolbađı*

gümüř eskitme R-07 | M-709



*antik kolbađı*

gümüř eskitme R-07 | M-701



*antik kolbađı*

gümüř eskitme R-07 | M-702



*antik kolbađı*

gümüř eskitme R-07 | M-700



*antik kolbađı*

gümüř eskitme R-07 | M-703



*antik kolbađı*

gümüř eskitme R-07 | M-704





# renso başlıklar

*antik renso*

altın eskitme R-011 M-706



*antik renso*

altın eskitme R-011 M-708



*antik renso*

altın eskitme R-011 M-707



*antik renso*

altın eskitme R-011 M-705



*antik renso*

altın eskitme R-011 M-709



*antik renso*

altın eskitme R-011 M-701



*antik renso*

altın eskitme R-011 M-700



*antik renso*

altın eskitme R-011 M-702



*antik renso*

altın eskitme R-011 M-703



*antik renso*

altın eskitme R-011 M-704



# renso başlıklar

**antik renso**

beyaz eskitme R-05 | M-706



**antik renso**

beyaz eskitme R-05 | M-708



**antik renso**

beyaz eskitme R-05 | M-707



**antik renso**

beyaz eskitme R-05 | M-705



**antik renso**

beyaz eskitme R-05 | M-709



**antik renso**

beyaz eskitme R-05 | M-701



**antik renso**

beyaz eskitme R-05 | M-700



**antik renso**

beyaz eskitme R-05 | M-702



**antik renso**

beyaz eskitme R-05 | M-703



**antik renso**

beyaz eskitme R-05 | M-704



# renso başlıklar

**antik renso**

gümüş eskitme R-07 | M-706



**antik renso**

gümüş eskitme R-07 | M-708



**antik renso**

gümüş eskitme R-07 | M-707



**antik renso**

gümüş eskitme R-07 | M-705



**antik renso**

gümüş eskitme R-07 | M-709



**antik renso**

gümüş eskitme R-07 | M-701



**antik renso**

gümüş eskitme R-07 | M-700



**antik renso**

gümüş eskitme R-07 | M-702



**antik renso**

gümüş eskitme R-07 | M-703



**antik renso**

gümüş eskitme R-07 | M-704



# teknik

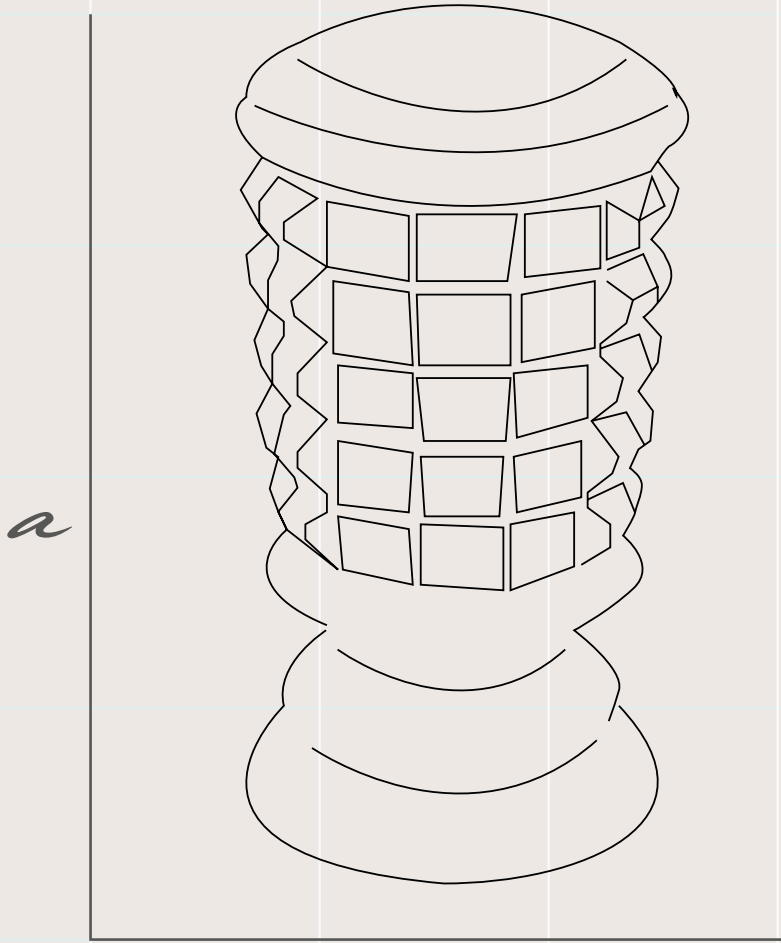

a

b

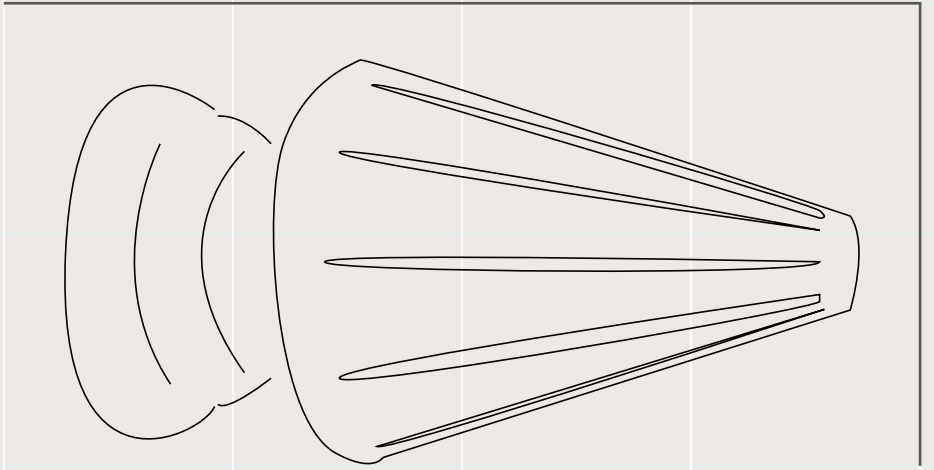

x

y

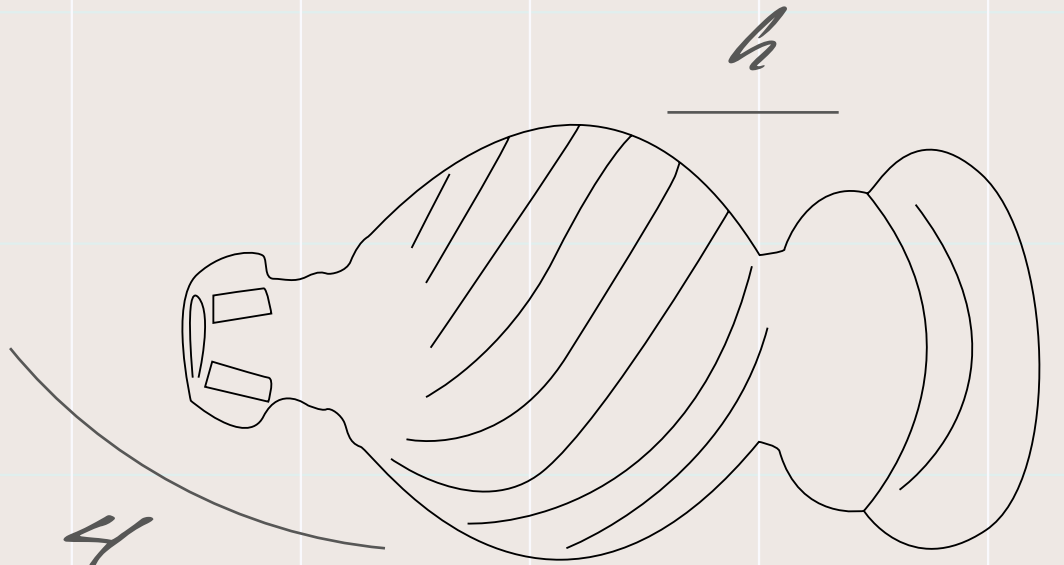

b

4

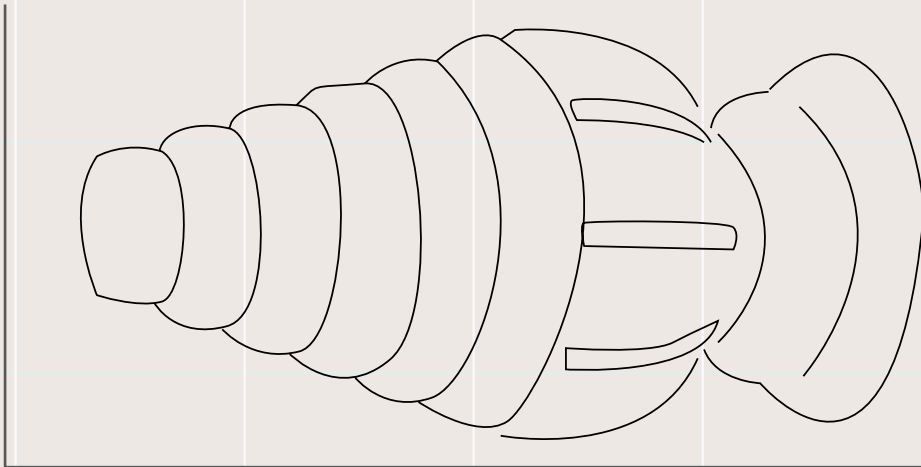

1

3

# *kolbağı-renso teknik*

Başlık 706

100mm

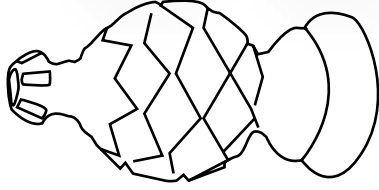

55 mm

Başlık 708

100 mm

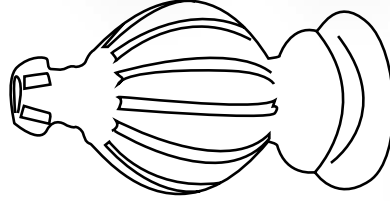

55 mm

Başlık 707

100 mm

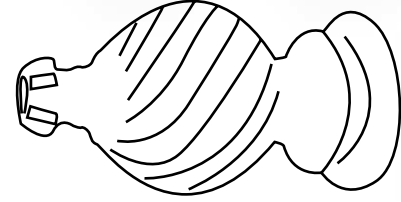

55 mm

Başlık 705

100 mm

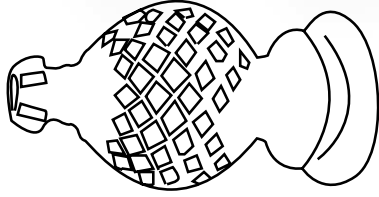

55 mm

Başlık 709

87 mm

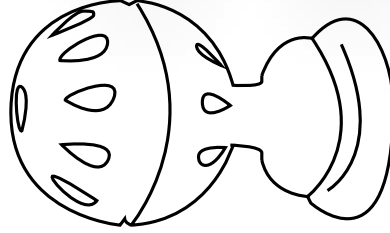

54 mm

Başlık 701

110 mm

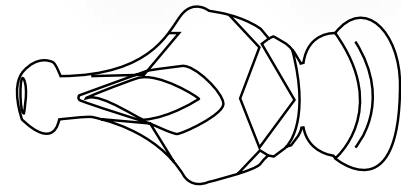

55 mm

Başlık 702

108 mm

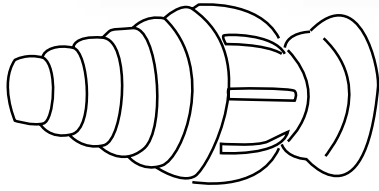

54 mm

Başlık 700

110 mm

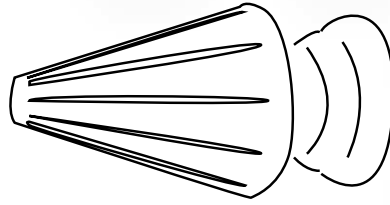

53 mm

Başlık 703

100 mm

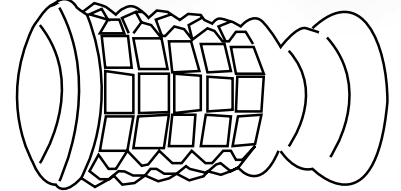

52 mm

Başlık 704

100 mm

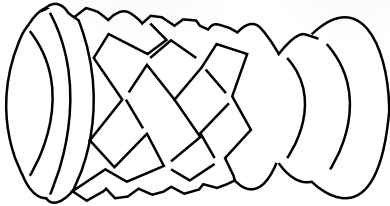

53 mm



*Kiraz*

# antik sarkıt

*antik sarkıt*

altın eskitme R-01 | M-706



*antik sarkıt*

altın eskitme R-01 | M-708



*antik sarkıt*

altın eskitme R-01 | M-707



*antik sarkıt*

altın eskitme R-01 | M-705



*antik sarkıt*

altın eskitme R-01 | M-709



*antik sarkıt*

altın eskitme R-01 | M-701



*antik sarkıt*

altın eskitme R-01 | M-702



*antik sarkıt*

altın eskitme R-01 | M-700



*antik sarkıt*

altın eskitme R-01 | M-703



*antik sarkıt*

altın eskitme R-01 | M-704



# antik sarkıt

## antik sarkıt

beyaz eskitme R-05 | M-706



## antik sarkıt

beyaz eskitme R-05 | M-708



## antik sarkıt

beyaz eskitme R-05 | M-707



## antik sarkıt

beyaz eskitme R-05 | M-705



## antik sarkıt

beyaz eskitme R-05 | M-709



## antik sarkıt

beyaz eskitme R-05 | M-701



## antik sarkıt

beyaz eskitme R-05 | M-702



## antik sarkıt

beyaz eskitme R-05 | M-700



## antik sarkıt

beyaz eskitme R-05 | M-703



## antik sarkıt

beyaz eskitme R-05 | M-704



# antik sarkıt

## antik sarkıt

gümüş eskitme R-07 | M-706



## antik sarkıt

gümüş eskitme R-07 | M-708



## antik sarkıt

gümüş eskitme R-07 | M-707



## antik sarkıt

gümüş eskitme R-07 | M-705



## antik sarkıt

gümüş eskitme R-07 | M-709



## antik sarkıt

gümüş eskitme R-07 | M-701



## antik sarkıt

gümüş eskitme R-07 | M-702



## antik sarkıt

gümüş eskitme R-07 | M-700



## antik sarkıt

gümüş eskitme R-07 | M-703



## antik sarkıt

gümüş eskitme R-07 | M-704



# teknik parçalar

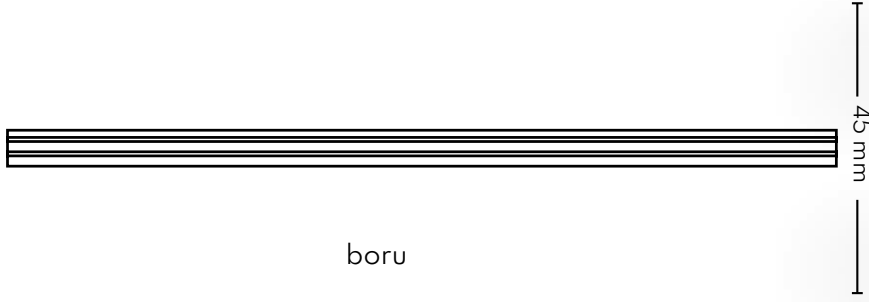

boru

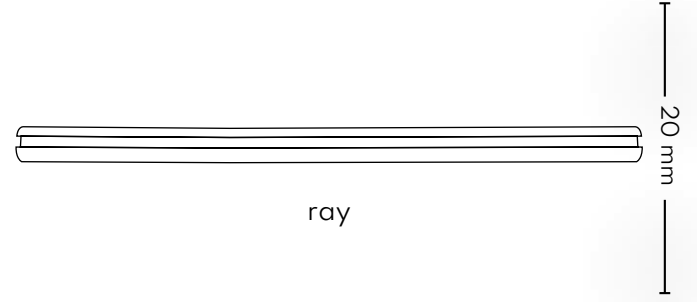

ray

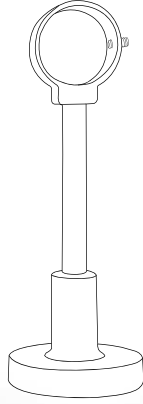

tekli ayak

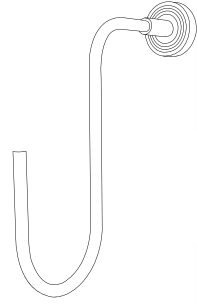

kolbağı

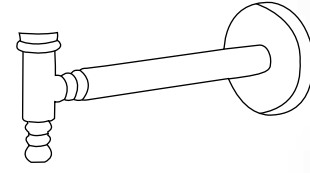

renso

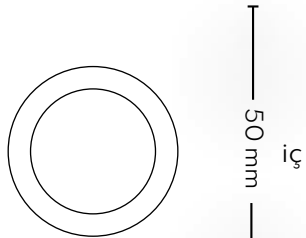

halka

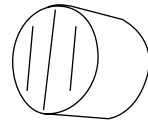

ray tapa

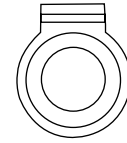

ray kelepçe





**KIRAZLI AHSAP PERDE SİSTEMLERİ A.Ş.**

Merkez: İnkılap Mah. Vatan Cad. No.88

Ümraniye İSTANBUL

Fabrika: Tepecik Mah. İstanbul Cad. No.21

Dilovası KOCAELİ

Telefon: +90 216 630 24 22

Mobil: +90 542 201 42 24

info@kirazahsap.com | www.kirazahsap.com





# *ahşap rustik*



# *ahşap rustik perde*

Kumaş veya tül perdelerin uygulamasında kullanılan kornejlerin yerine rustik borulara adapte edilmiş perdelerdir. Rustik perdeler, özellikle perdelik ve kartonpiyer bulunmayan mekânlarda tercih edilmelidir. Rustik perdelerde taşıyıcı borular (rustik) duvar veya tavana özel ayaklarıyla monte edilir. Kumaş perde ahşap veya metal halkalarla boru üzerinde hareket ettirilir. Kumaş perde isteğe göre farklı pililerle de dikilebilir. Rustik perdelerde pencere ölçüsü alındıktan sonra kumaş hesabı yapılır. Kumaş hesabı, yapılacak modele göre değişmektedir. Rustik perdede müşterinin isteğine göre pile payı değişebilir.





# uygulama seenekleri

## tekli



Bir adet ahşap kaplamalı rustik borudan oluşan üründür.  
Tek kademeli perde kullanımları için öneriyoruz.

## ikili



Bir adet ahşap kaplamalı rustik borudan ve bir adet ray sisteminden oluşan üründür.  
İki kademeli perde kullanımları için öneriyoruz.

## üçlü



İki adet ahşap kaplamalı rustik borudan ve bir adet ray sisteminden oluşan üründür.  
Üç kademeli perde kullanımları için öneriyoruz.





# renk seenekleri

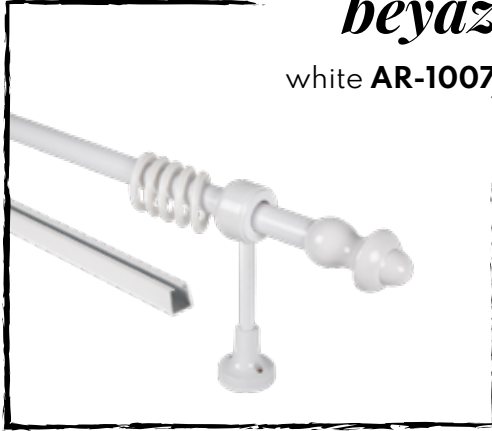

*beyaz*  
white AR-1007



*naturel*  
natural AR-1006



*meşe*  
oak AR-1005



*altın*  
gold AR-1008



*kızıl meşe*  
red oak AR-1004



*ceviz*  
walnut AR-1003



*gümüş*  
silver AR-1009



*antrasit*  
anthracite AR-1011



*siyah*  
black AR-1010



# aparar ve parçalar



Boru Ø 25 mm



Ray



Başlık

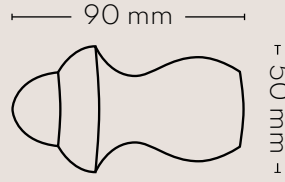

Tapa Başlık

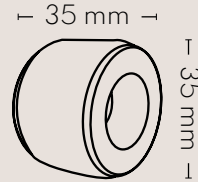

Halka

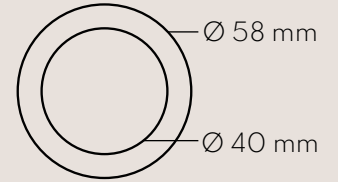

Ek Aparat

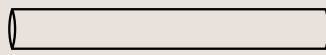

Dönüş Aparatı

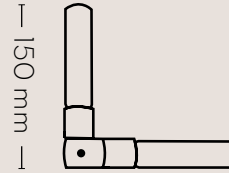

Raylı Dönüş Aparatı

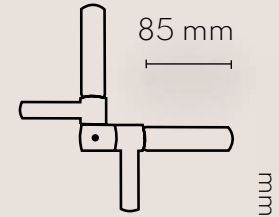

Standart Ayak

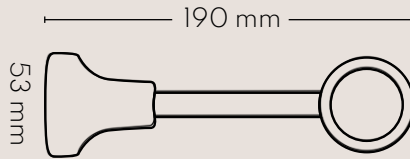

Raylı Duvar

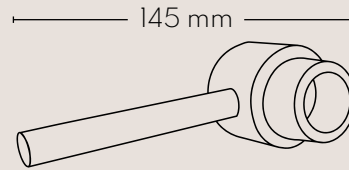

Duvar Bağlantısı

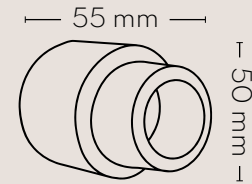

Çiftli Ayak

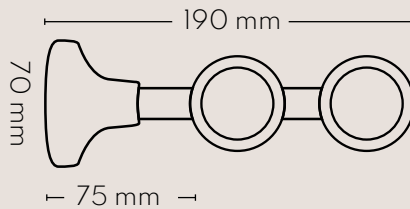

Raylı Flanş

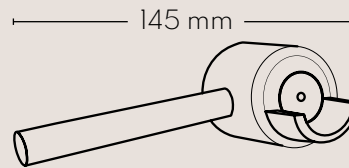

Duvar Flanş

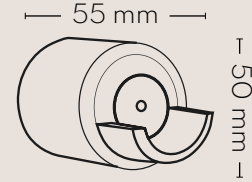



EXPERT

somfy.

**KIRAZLI AHSAP PERDE SİSTEMLERİ A.Ş.**

Merkez: İnkılap Mah. Vatan Cad. No.88

Ümraniye İSTANBUL

Fabrika: Tepecik Mah. İstanbul Cad. No.21

Dilovası KOCAELİ

Telefon: +90 216 630 24 22

Mobil: +90 542 201 42 24

info@kirazahsap.com | www.kirazahsap.com



# *retro rustik*



# *retro rustik perde*

Kiraz Rustik olarak mekânlarınıza şıklık, modernlik ve yenilik getirecek yeni ürünümüzü sunuyoruz. Tasarımlarınızda farkınızı ortaya koymak için, yeni ve özel üretim olan **Retro Rustik** ile siz de perdelerinizi yenilemek isteyeceksiniz!

Mekânlarınızda yeni bir dünya yaratmak istediğinizde perdeler en önemli tamamlayıcı ürünlerdir.

Retro Rustik yetenekli ustalarımızın el işçiliği ile özel olarak kayın ağacından üretilmektedir. Doğal bir görünüme sahip olan ahşap başlığı, Ø 40 mm alüminyum boru, 8 farklı başlık modeli, 6 farklı patine renk seçenekleri ile ürün gruplarımız arasında yerini almaktadır.

Retro Rustik, Retro Kolbağı ve Retro Renso takımları ile ortamda bütünlük sağlayarak oluşturmak istediğiniz konseptinizi tamamlamaktadır.





# *uygulama seenekleri*

*tekli*



*raylı*





# *rustik renkler*



***retro rustik***  
beyaz R-09 | M-400



***retro rustik***  
beyaz R-09 | M-409



***retro rustik***  
beyaz R-09 | M-402



***retro rustik***  
beyaz R-09 | M-406



***retro rustik***  
beyaz R-09 | M-403



***retro rustik***  
beyaz R-09 | M-412



***retro rustik***  
beyaz R-09 | M-405



***retro rustik***  
beyaz R-09 | M-411

# *rustik renkler*



# *rustik renkler*

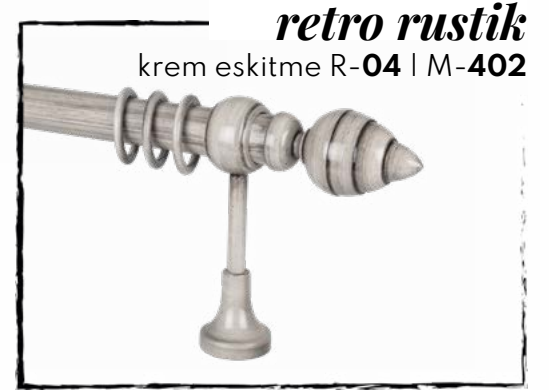

# *rustik renkler*



# *rustik renkler*

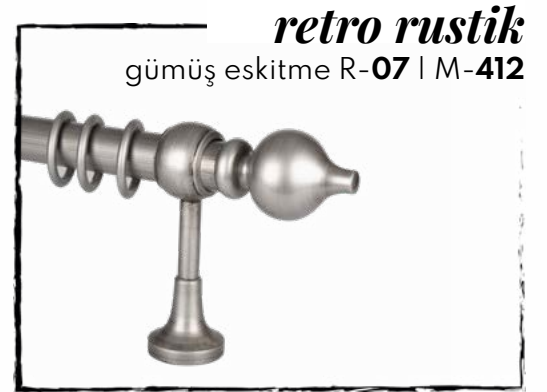

# *rustik renkler*



***retro rustik***  
siyah R-08 | M-400



***retro rustik***  
siyah R-08 | M-409



***retro rustik***  
siyah R-08 | M-402



***retro rustik***  
siyah R-08 | M-406



***retro rustik***  
siyah R-08 | M-403



***retro rustik***  
siyah R-08 | M-412



***retro rustik***  
siyah R-08 | M-405



***retro rustik***  
siyah R-08 | M-411

# *rustik teknik*

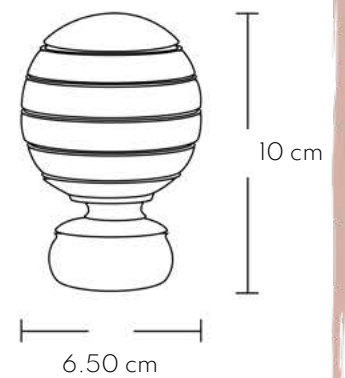
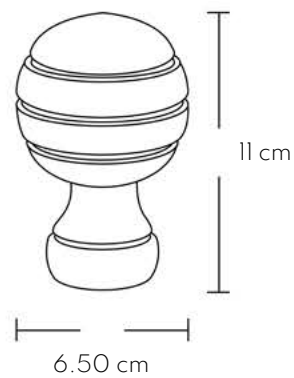
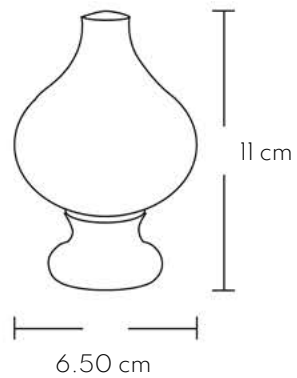
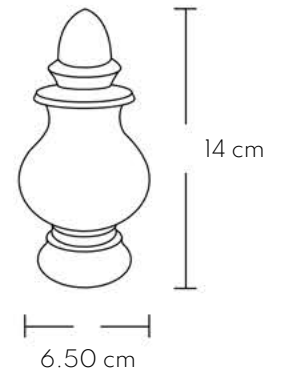
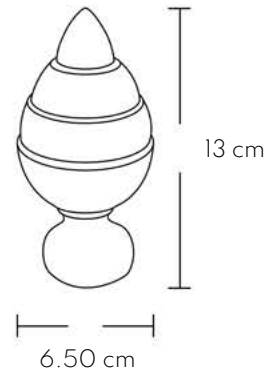
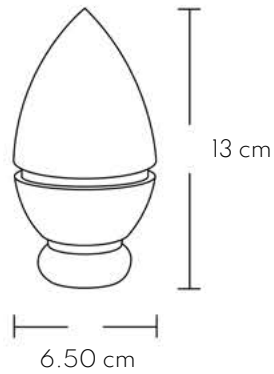
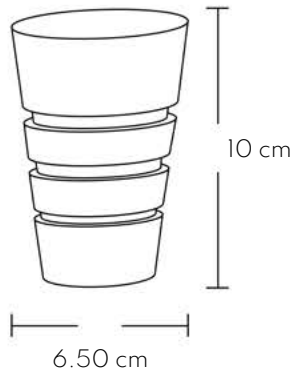

*renkler*





# *kolbađı renkler*

*retro kolbađı*

beyaz R-09



*retro kolbađı*

krem altın R-05



*retro kolbađı*

krem eskitme R-04



*retro kolbađı*

altın eskitme R-01



*retro kolbađı*

gümüş eskitme R-07



*retro kolbađı*

siyah R-08



\*Renk seçimi yapınız.



# başlıklar

*retro kolbağı*

M-400



*retro kolbağı*

M-409



*retro kolbağı*

M-402



*retro kolbağı*

M-406



*retro kolbağı*

M-403



*retro kolbağı*

M-412



*retro kolbağı*

M-405



*retro kolbağı*

M-411



\*başlık seçimi yapınız.



# *renso renkler*

## *retro renso*

beyaz R-09



## *retro renso*

krem altın R-05



## *retro renso*

krem eskitme R-04



## *retro renso*

altın eskitme R-01



## *retro renso*

gümüş eskitme R-07



## *retro renso*

siyah R-08



\*Renk seçimi yapınız.



# *renso başlıklar*

*retro renso*  
M-400



*retro renso*  
M-409



*retro renso*  
M-402



*retro renso*  
M-406



*retro renso*  
M-403



*retro renso*  
M-412



*retro renso*  
M-405



*retro renso*  
M-411



\*başlık seçimi yapınız.

# *kolbağrı - renso teknik*

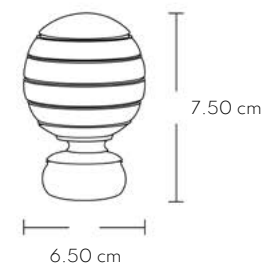
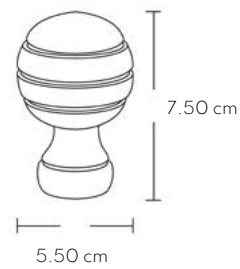
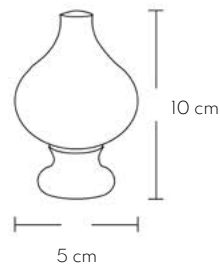
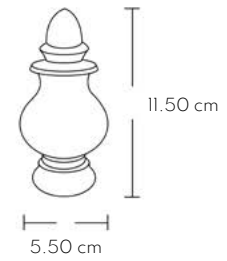
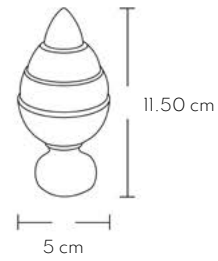
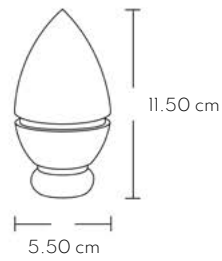
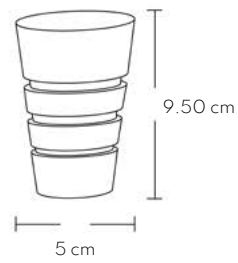



# *rustik teknik*



boru -Ø 40 cm



ray



çifli ayak



çifli - c ayak

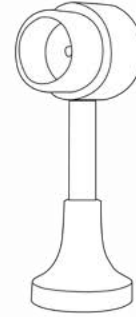

flanş tavan

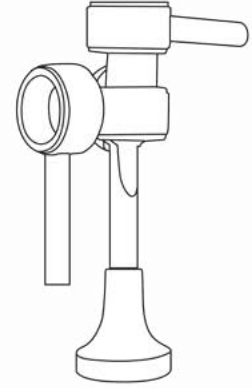

raylı dönüş

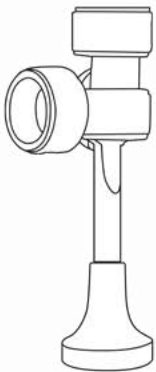

dönüş



flanş duvar



c flanş duvar



ek aparat







**KIRAZLI AHSAP PERDE SİSTEMLERİ A.Ş.**

Merkez: İnkılap Mah. Vatan Cad. No.88

Ümraniye İSTANBUL

Fabrika: Tepecik Mah. İstanbul Cad. No.21

Dilovası KOCAELİ

Telefon: +90 216 630 24 22

Mobil: +90 542 201 42 24

info@kirazahsap.com | www.kirazahsap.com

